

wavin

EKOPLASTIK®

CONNECT TO BETTER

Каталог на изделията

Система Ekorplastik

Водни инсталации
и отопление



Съдържание

Основна информация за асортимента.....	3
Предимства, Означение на тръбите S (SDR) вместо PN	5
Изделия за питейна (студена) вода, топла вода и отопление (I.)	6
Комплексно предложение на фитинги за гипсокартон (I.)	26
Специални фитинги за отопление (I.)	27
Изделия само за питейна (студена) вода (II.)	29
Изделия за временно, нестандартно използване (III.)	30
Принадлежности (IV.).....	31

Основна информация за асортимента

Системата Ekorplastik е предназначена за разводка на топла и студена вода, за подово и централно отопление. Тръбопроводите Ekorplastik могат да се използват и за пренос на въздух. За други течни, газообразни или твърди вещества.

Използване на тръби



	PPR PN10	PPR PN16	PPR PN20	EVO	STABI PLUS	FIBER BASALT PLUS	FIBER BASALT OXY	FIBER BASALT CLIMA
	Ø 20-125 мм	Ø 16-125 мм	Ø 16-125 мм	Ø 16-125 мм	Ø 16-110 мм	Ø 20-125 мм	Ø 20-63 мм	Ø 20-125 мм
	●	●	●	●	●	●		●
		●	●	●	●	●		●
			●	●	●	●	●	
макс. 70 °C								
					●	●	●	
макс. 90 °C								

Тръби от материал нова генерация - PP-RCT

Многослойни тръби от материал нова генерация - PP-RCT

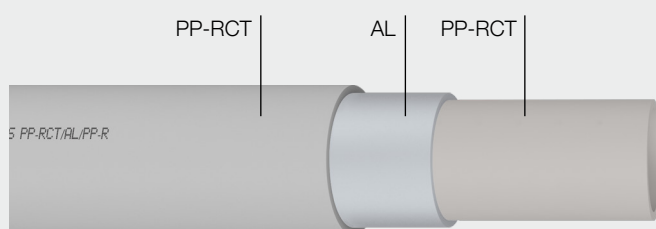

STABI PLUS

- ⦿ 3x по-малко топлинно удължение отколкото еднопластови тръбите от полипропилен
- ⦿ кислородна бариера
- ⦿ подходяща за отопление

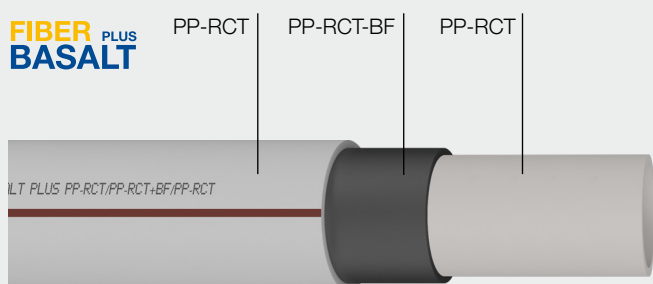

FIBER BASALT PLUS

- ⦿ 3x по-малко топлинно удължение отколкото еднопластови тръбите от полипропилен
- ⦿ без нужда от обрязване преди заварка
- ⦿ за топла вода и подово отопление

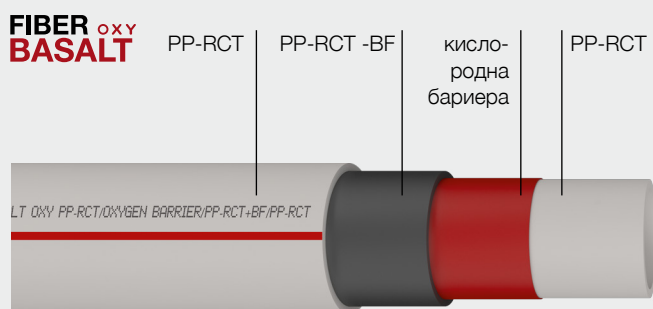

FIBER BASALT OXY **НОВО**

- ⦿ 3x по-малко топлинно удължение отколкото еднопластови тръбите от полипропилен
- ⦿ кислородна бариера
Кислородната защита, отговаря на изискванията на DIN 4726 и ISO 17455
- ⦿ без нужда от обрязване преди заварка
- ⦿ подходяща за отопление

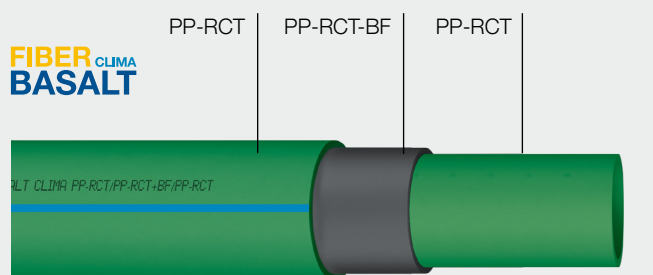

FIBER BASALT CLIMA

- ⦿ 3x по-малко топлинно удължение отколкото еднопластови тръбите от полипропилен
- ⦿ без нужда от обрязване преди заварка
- ⦿ за студена вода и климатични инсталации

Предимства

- ⦿ комплектен набор от фитинги с размери 16 - 125 mm
- ⦿ произведени от гранулат от водещи европейски производители
- ⦿ уникална трислойна тръба с базалтови влакна
- ⦿ напълно нов тип материал 4 генерация - PP-RCT

Означение на тръбите S (SDR) вместо PN

В съответствие със стандартите CSN EN ISO15874 и DIN 8077 трябва да се означават тръбите с „S“ или „SDR“ вместо „PN“.

$$\text{SDR} = 2S + 1$$
$$\text{SDR} \approx D/t$$

Пояснения:

D = външен
диаметър
 t = дебелина
на стената

- ⦿ означението „PN“ показва допустимото работно налягане при 20 °C и дълговечност 50 години.

- ⦿ стандартите CSN EN ISO 15874 а DIN 8077 вече не посочват „PN“ за тръби с най-нисък конструктивен коефициент.

- ⦿ тръбите от PPR означаваме традиционно с „PN“ (предишното означение за гамата налягане), въпреки че стойностите за посочените по-горе дефиниции вече не отговарят.

В каталога, за по-лесна ориентация, са посочени изчислителните стойности за „PN“ за тръби от PP-RCT (при изчисленията е използвана формулата за „PN“ съгласно стандарта). Експлоатационните параметри на тръбите са посочени в маркировката на тръбите и в Инструкцията за монтаж.

Изделия за питейна (студена) вода, топла вода и отопление (I.)

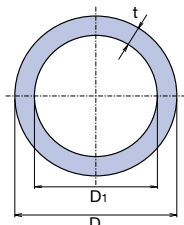

Тръба S 5 / PN 10 / SDR 11

D	D ₁	t	l			КОД
MM	MM	MM	MM	M	КГ/М	
20	15,6	2,2	4000	100	0,121	STR020P10X
25	20,4	2,3	4000	60	0,164	STR025P10X
32	26,2	2,9	4000	40	0,258	STR032P10X
40	32,6	3,7	4000	24	0,413	STR040P10X
50	40,8	4,6	4000	16	0,636	STR050P10X
63	51,4	5,8	4000	12	1,004	STR063P10X
75	61,4	6,8	4000	8	1,401	STR075P10X
90	73,6	8,2	4000	4	2,014	STR090P10X
110	90,0	10,0	4000	4	3,009	STR110P10X
125	102,2	11,4	4000	4	3,910	STR125P10X

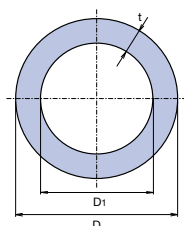

Тръба S 3,2 / PN 16 / SDR 7,4

D	D ₁	t	l			КОД
MM	MM	MM	MM	M	КГ/М	
16	11,6	2,2	4000	160	0,094	STR016P16X
20	14,4	2,8	4000	100	0,145	STR020P16X
25	18,0	3,5	4000	60	0,227	STR025P16X
32	23,2	4,4	4000	40	0,367	STR032P16X
40	29,0	5,5	4000	24	0,566	STR040P16X
50	36,2	6,9	4000	16	0,886	STR050P16X
63	45,8	8,6	4000	12	1,387	STR063P16X
75	54,4	10,3	4000	8	1,990	STR075P16X
90	65,4	12,3	4000	4	2,839	STR090P16X
110	79,8	15,1	4000	4	4,274	STR110P16X
125	90,8	17,1	4000	4	5,530	STR125P16X

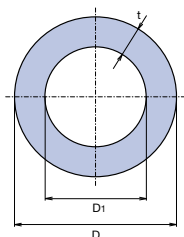

Тръба S 2,5 / PN 20 / SDR 6

D	D ₁	t	l			КОД
MM	MM	MM	MM	M	КГ/М	
16	10,6	2,7	4000	160	0,107	STR016P20X
20	13,2	3,4	4000	100	0,169	STR020P20X
25	16,6	4,2	4000	60	0,259	STR025P20X
32	21,2	5,4	4000	40	0,423	STR032P20X
40	26,6	6,7	4000	24	0,657	STR040P20X
50	33,4	8,3	4000	16	1,013	STR050P20X
63	42,0	10,5	4000	12	1,611	STR063P20X

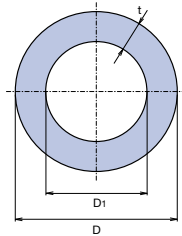
Тръба S 2,5 / PN 20 / SDR 6 – 3 м

D	D ₁	t	l	📦	⚖️	КОД
MM	MM	MM	MM	М	КГ/М	
20	13,2	3,4	3000	75	0,169	STR020P203
25	16,6	4,2	3000	45	0,259	STR025P203
32	21,2	5,4	3000	30	0,423	STR032P203

Всички тръби, посочени в каталога, могат да бъдат изработени след предварително съгласуване с дължини различни от тези в каталога.

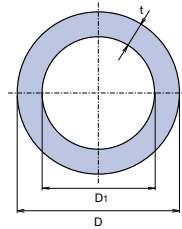
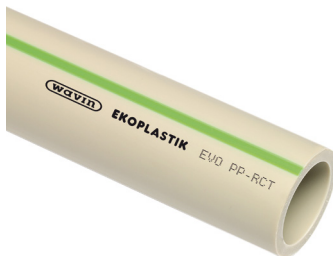
Тръба EVO 16 мм S 3,2 / SDR 7,4 / PN 28 (изчислено)
Тръба EVO 20-125 мм S 4 / SDR 9 / PN 22 (изчислено)

D	D ₁	t	l	📦	⚖️	КОД
MM	MM	MM	MM	М	КГ/М	
16	11,6	2,2	4000	160	0,095	STRE016S32
20	15,4	2,3	4000	100	0,127	STRE020S4
25	19,4	2,8	4000	60	0,191	STRE025S4
32	24,8	3,6	4000	40	0,313	STRE032S4
40	31,0	4,5	4000	24	0,487	STRE040S4
50	38,8	5,6	4000	16	0,755	STRE050S4
63	48,8	7,1	4000	12	1,200	STRE063S4
75	58,2	8,4	4000	8	1,690	STRE075S4
90	69,8	10,1	4000	4	2,440	STRE090S4
110	85,4	12,3	4000	4	3,620	STRE110S4
125	97,0	14,0	4000	4	4,660	STRE125S4

EVO® PP-RCT

За качествена заварка трябва да се спазва - времето за загревяне според диаметъра на тръбата
- температурата за загревяне 260 °C

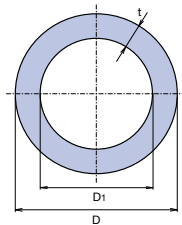
Тръба - STABI PLUS 16-63 мм
S 3,2 / SDR 7,4 / PN 28 (изчислено)
Тръба - STABI PLUS 75-110 мм
S 4 / SDR 9 / PN 22 (изчислено)

D	De	D ₁	t	l	📦	⚖️	КОД
MM	MM	MM	MM	MM	М	КГ/М	
16	17,9	11,4	2,2	4000	120	0,137	STRS016RCT
20	21,9	14,4	2,8	4000	80	0,207	STRS020RCT
25	26,9	18,0	3,5	4000	60	0,298	STRS025RCT
32	33,9	23,2	4,4	4000	40	0,465	STRS032RCT
40	41,9	29,0	5,5	4000	20	0,692	STRS040RCT
50	52,0	36,2	6,9	4000	16	1,046	STRS050RCT
63	65,0	45,8	8,6	4000	8	1,587	STRS063RCT
75	77,0	58,2	8,4	4000	8	1,860	STRS075RCT
90	92,0	69,8	10,1	4000	4	2,673	STRS090RCT
110	112,0	85,4	12,3	4000	4	4,022	STRS110RCT

Ø 20 - 63 mm с неперфорирано фолио,

Ø 75 - 110 mm с перфорирано фолио

Изделия за питейна (студена) вода, топла вода и отопление (I.)



**FIBER PLUS
BASALT**

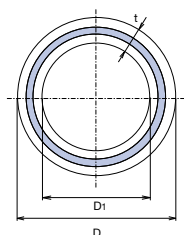

Тръба FIBER BASALT PLUS 20-63 мм

S 3,2 / SDR 7,4 / PN 28 (изчислено)

Тръба FIBER BASALT PLUS 75-125 мм

S 4 / SDR 9 / PN 22 (изчислено)

D	D ₁	t	l			КОД
MM	MM	MM	MM	M	KG/M	
20	14,4	2,8	4000	100	0,153	STRFB020TRCT
25	18,0	3,5	4000	60	0,239	STRFB025TRCT
32	23,2	4,4	4000	40	0,385	STRFB032TRCT
40	29,0	5,5	4000	24	0,599	STRFB040TRCT
50	36,2	6,9	4000	16	0,941	STRFB050TRCT
63	45,8	8,6	4000	12	1,471	STRFB063TRCT
75	58,2	8,4	4000	8	1,764	STRFB075TRCT
90	69,8	10,1	4000	4	2,546	STRFB090TRCT
110	85,4	12,3	4000	4	3,781	STRFB110TRCT
125	97,0	14,0	4000	4	4,891	STRFB125TRCT

Произвежда се по поръчка със срок на доставка 30 дни.

НОВО



**FIBER OXY
BASALT**

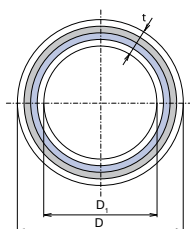

Тръба FIBER BASALT OXY

S 3,2 / SDR 7,4 / PN 28 (изчислено)

D	D ₁	t	l			КОД
MM	MM	MM	MM	M	KG/M	
20	14,4	2,8	4000	100	0,153	STRFBO020TRCT
25	18,0	3,5	4000	60	0,239	STRFBO025TRCT
32	23,2	4,4	4000	40	0,385	STRFBO032TRCT
40	29,0	5,5	4000	24	0,599	STRFBO040TRCT
50	36,2	6,9	4000	16	0,941	STRFBO050TRCT
63	45,8	8,6	4000	12	1,471	STRFBO063TRCT

налични в 4^{-то} тримесечие 2017

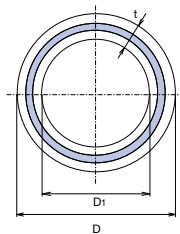
**FIBER CLIMA
BASALT**

Тръба FIBER BASALT CLIMA 20-25 мм
S 4 / SDR 9 / PN 22 (изчислено)
Тръба FIBER BASALT CLIMA 32-125 мм
S 5 / SDR 11 / PN 18 (изчислено)

D	D ₁	t	l			КОД
MM	MM	MM	MM	М	кг/м	
20	14,4	2,3	4000	100	0,128	TTRFBC020TRCT
25	18,0	2,8	4000	60	0,199	TTRFBC025TRCT
32	26,2	2,9	4000	40	0,269	TTRFBC032TRCT
40	32,6	3,7	4000	24	0,428	TTRFBC040TRCT
50	40,8	4,6	4000	16	0,664	TTRFBC050TRCT
63	51,4	5,8	4000	12	1,050	TTRFBC063TRCT
⊕ 75	61,4	6,8	4000	8	1,501	TTRFBC075TRCT
⊕ 90	73,6	8,2	4000	4	2,122	TTRFBC090TRCT
⊕ 110	90,0	10,0	4000	4	3,160	TTRFBC110TRCT
⊕ 125	102,2	11,4	4000	4	4,082	TTRFBC125TRCT

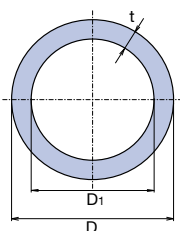
⊕ Произвежда се по поръчка със срок на доставка 30 дни.

Тръба на кангал

D	S	SDR	t	l		КОД
MM			MM	М	кг/м	
16	3,2(16)	7,4	2,2	100	0,094	STRK016P17
				200		STRK016P16
20	5,0(10)	11	2,2	100	0,121	STRK020P11
				200		STRK020P10
20	3,2(16)	7,4	2,8	100	0,145	STRK020P17
				200		STRK020P16
16	2,5(20)	6	2,7	100	0,107	STRK016P21
				200		STRK016P20
20	2,5(20)	6	3,4	100	0,169	STRK020P21
				200		STRK020P20

Изделия за питейна (студена) вода, топла вода и отопление (I.)

Коляно 90 °

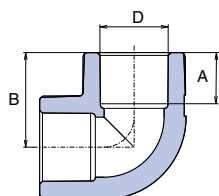

D	A	B	☐	☐	⚖	КОД
мм	мм	м	I.	II.	кг/бр	
16	13,0	23,2	50	250	0,010	SKO01690XX
20	14,5	26,8	50	500	0,018	SKO02090XX
25	16,0	31,0	50	250	0,030	SKO02590XX
32	18,0	36,5	25	150	0,056	SKO03290XX
40	20,5	43,0	10	70	0,100	SKO04090XX
50	23,5	51,0	10	40	0,158	SKO05090XX
63	27,5	61,5	5	15	0,334	SKO06390XX
75	30,0	70,1	2	6	0,558	SKO07590XX
90	33,0	82,0	1	5	1,010	SKO09090XX
110	37,0	95,0		1	1,344	SKO11090XX
125	40,0	105,0		1	1,640	SKO12590XX

☉ Информация за срока на доставка при поискване.

Коляно 90 ° мъжко / женско

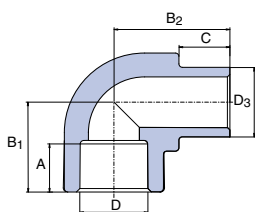

D, D ₃	A	B ₁	B ₂	C	☐	☐	⚖	КОД
мм	мм	мм	мм	мм	I.	II.	кг/бр	
16	13,0	21,3	25,0	12,0	50	250	0,006	SKO116XXXX
20	14,5	26,8	30,3	13,0	50	200	0,014	SKO120XXXX
25	16,0	31,0	35,0	14,0	50	100	0,024	SKO125XXXX
32	18,0	36,5	42,2	16,0	25	100	0,044	SKO132XXXX

Коляно 45 °

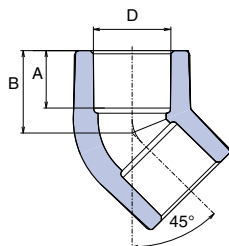

D	A	B	☐	☐	⚖	КОД
мм	мм	м	I.	II.	кг/бр	
16	13,0	18,7		50	0,008	SKO01645XX
20	14,5	20,8	100	500	0,014	SKO02045XX
25	16,0	24,0	50	250	0,024	SKO02545XX
32	18,0	27,0	20	80	0,042	SKO03245XX
40	20,5	31,5	5	25	0,082	SKO04045XX
50	23,5	36,5	5	20	0,122	SKO05045XX
63	27,5	43,0	5	10	0,280	SKO06345XX
75	30,0	48,1	2	6	0,406	SKO07545XX
90	33,0	54,1	1	6	0,654	SKO09045XX
110	37,0	62,1		1	0,965	SKO11045XX

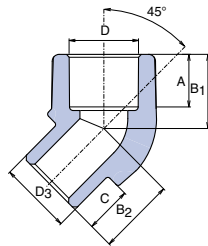

Коляно 45 ° мъжко / женско

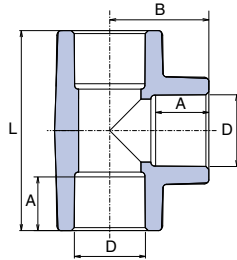
D	D ₃	A	B ₁	B ₂	D	☐ I.	☐ II.	⚖ кг/бр	КОД
мм	мм	мм	мм	мм	мм	л.	л.	кг/бр	
16	16	13,0	18,7	18,7	12,0	50	0,008		SKO11645XX
20	20	14,5	20,8	21,5	13,0	100	0,012		SKO12045XX
25	25	16,0	24,0	24,0	14,0	100	0,026		SKO12545XX

Тройник

D	A	B	L	☐ I.	☐ II.	⚖ кг/бр	КОД
мм	мм	мм	мм	л.	л.	кг/бр	
16	13,0	23,2	46,4	50		0,012	STK016XXXX
20	14,5	27,0	54,0	50	300	0,022	STK020XXXX
25	16,0	32,0	60,0	50	200	0,038	STK025XXXX
32	18,0	35,7	70,0	20	100	0,070	STK032XXXX
40	20,5	38,5	86,2	10	50	0,124	STK040XXXX
50	23,5	51,0	102,0	5	30	0,196	STK050XXXX
63	27,5	61,5	123,0	5	15	0,430	STK063XXXX
75	30,0	70,1	140,2	1	5	0,644	STK075XXXX
90	33,0	83,1	166,2	1		1,134	STK090XXXX
110	37,0	99,1	198,2	1		1,962	STK110XXXX
⊕ 125	40,0	105,0	210,0	1		2,030	STK125XXXX

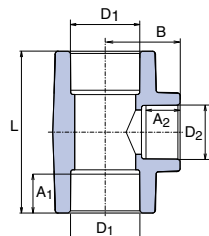
⊕ Информация за срока на доставка при поискване.

Тройник редукиривен

D ₁	D ₂	A ₁	A ₂	L	B	☐ I.	☐ II.	⚖ кг/бр	КОД
мм	мм	мм	мм	мм	мм	л.	л.	кг/бр	
20	16	14,5	13,0	53,0	23,0	50		0,018	STKR02016X
25	20	16,0	14,5	55,0	29,0	50	200	0,032	STKR02520X
32	20	18,0	14,5	67,0	34,4	50	150	0,052	STKR03220X
32	25	18,0	16,0	73,0	34,4	25	100	0,062	STKR03225X
40	20	20,5	14,5	64,5	38,0	20	60	0,082	STKR04020X
40	25	20,5	16,0	66,0	40,2	10	50	0,090	STKR04025X
40	32	20,5	18,0	86,0	41,5	10	40	0,132	STKR04032X
50	25	23,5	16,0	77,0	43,4	5	15	0,138	STKR05025X
50	32	23,5	18,0	84,0	46,0	5	30	0,152	STKR05032X
50	40	23,5	20,5	91,4	47,4	5	15	0,176	STKR05040X
63	25	27,5	16,0	85,0	49,9	5	10	0,239	STKR06325X
63	32	27,5	18,0	92,0	52,0	5	15	0,290	STKR06332X
63	40	27,5	20,5	100,0	54,6	5	15	0,306	STKR06340X
63	50	27,5	23,5	110,0	57,2	5	15	0,340	STKR06350X

Изделия за питейна (студена) вода, топла вода и отопление (I.)

Тройник двойноредуктивен

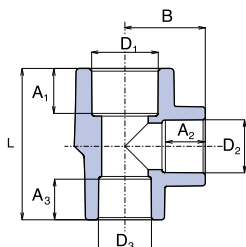

D ₁	D ₂	D ₃	A ₁	A ₂	A ₃	L	B	📦 I.	📦 II.	⚖️ кг/бр	КОД
25	20	20	16,0	14,5	14,5	55,2	29,3	10	50	0,028	STKR0252020
32	20	20	18,0	14,5	14,5	57,3	32,8	10	50	0,040	STKR0322020
32	20	25	18,0	14,5	16,0	58,9	32,8	10	50	0,044	STKR0322520
32	25	25	18,0	18,0	16,0	66,0	34,4	10	50	0,052	STKR0322525

Четирипътник

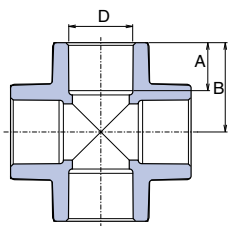

D ₃	A	B ₁	📦 I.	📦 II.	⚖️ кг/бр	КОД
20	14,5	26,3	25		0,024	SKRI020XXX
25	16,0	30,1	25		0,042	SKRI025XXX
32	18,0	35,0	10	40	0,070	SKRI032XXX
40	20,5	42,0	10	30	0,128	SKRI040XXX

Дъга 90°

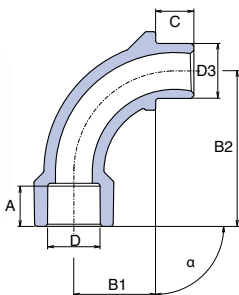

D	D ₃	A	B ₁	B ₂	C	α	📦 I.	📦 II.	⚖️ кг/бр	КОД
20	20	14,5	37,0	56,0	13,6	90°	25	100	0,022	SO02090XXX
25	25	16,0	45,0	67,0	14,6	90°	10	100	0,036	SO02590XXX

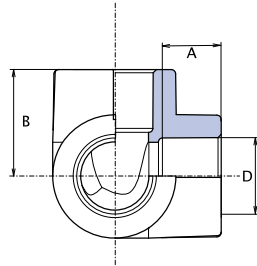

Трипътник

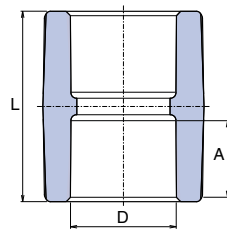
D	A	B	☐	☐	⚖	КОД
MM	MM	MM	I.	II.	кг/бр	
20	14,5	26,8	10	50	0,020	SKOT020XXX
25	16,0	29,5	10	40	0,032	SKOT025XXX
32	18,0	35,0	5	20	0,062	SKOT032XXX
40	20,5	41,5	5	15	0,108	SKOT040XXX

Муфа

D	A	L	☐	☐	⚖	КОД
MM	MM	MM	I.	II.	кг/бр	
16	13,0	33,0		50	0,006	SNA016XXXX
20	14,5	34,6	50	500	0,010	SNA020XXXX
25	16,0	37,8	50	250	0,018	SNA025XXXX
32	18,0	40,0	25	150	0,034	SNA032XXXX
40	20,5	48,0	20	80	0,056	SNA040XXXX
50	23,5	53,0	10	70	0,082	SNA050XXXX
63	27,5	65,0	5	30	0,118	SNA063XXXX
75	30,0	73,4	1	5	0,314	SNA075XXXX
90	33,0	79,2		1	0,470	SNA090XXXX
110	37,0	88,2		1	0,782	SNA110XXXX
⊕ 125	40,0	86,0		1	0,745	SNA125XXXX

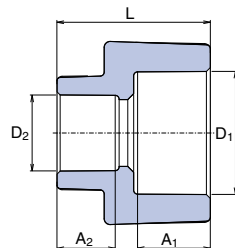
⊕ Информация за срока на доставка при поискване.

Редуктивна муфа

D1	D2	A1	D2	L	☐	☐	⚖	КОД
MM	MM	MM	MM	MM	I.	II.	кг/бр	
25	20	16,0	14,5	34,0	50	450	0,014	SRE02520XX
32	20	18,0	14,5	39,0	50	250	0,026	SRE03220XX
32	25	18,0	16,0	39,5	50	250	0,028	SRE03225XX

Изделия за питейна (студена) вода, топла вода и отопление (I.)

Редукция

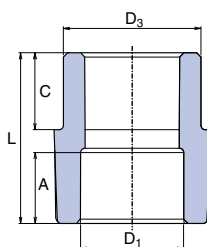

D3	D1	A	L	C	☐	☐	⚖	КОД
ММ	ММ	ММ	ММ	ММ	I.	II.	кг/бр	
20	16	13,0	32,5	13,0	50		0,006	SRE12016XX
25	20	14,5	34,0	14,0	50	500	0,010	SRE12520XX
32	20	14,5	40,0	16,0	50	200	0,016	SRE13220XX
32	25	16,0	39,5	16,0	50	300	0,018	SRE13225XX
40	20	14,5	47,0	18,5	10	50	0,024	SRE14020XX
40	25	16,0	45,4	18,5	10	50	0,026	SRE14025XX
40	32	18,0	48,2	18,5	20	60	0,034	SRE14032XX
50	25	16,0	41,3	21,3	10	50	0,042	SRE15025XX
50	32	18,0	55,5	22,0	10	50	0,052	SRE15032XX
50	40	20,5	52,0	22,0	10	50	0,048	SRE15040XX
63	25	16,0	49,3	25,3	5	10	0,070	SRE16325XX
63	32	18,0	62,5	25,3	5	10	0,080	SRE16332XX
63	40	20,5	58,5	25,3	5	10	0,078	SRE16340XX
63	50	23,5	58,5	25,3	5	10	0,078	SRE16350XX
75	40	20,5	64,5	28,9	5	20	0,116	SRE17540XX
75	50	23,5	64,5	28,9	5	20	0,120	SRE17550XX
75	63	27,5	71,5	28,9	1	5	0,210	SRE17563XX
90	63	27,5	64,5	33,4	1		0,221	SRE19063XX
90	75	30,0	78,0	33,4	1		0,290	SRE19075XX
110	75	30,0	60,0	39,4	1		0,268	SRE111075X
110	90	33,0	87,0	39,4	1		0,502	SRE111090X
☉125	110	40,0	100,3	42,4	1		0,678	SRE1125110

☉ Информация за срока на доставка при поискване.

Капа

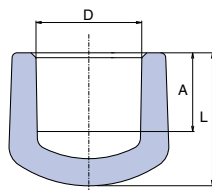

D	A	B	☐	☐	⚖	КОД
ММ	ММ	ММ	I.	II.	кг/бр	
16	13,5	20,9		50	0,004	SZA016XXXX
20	14,5	24,5	50	150	0,008	SZA020XXXX
25	16,0	28,0	50	150	0,014	SZA025XXXX
32	18,0	33,0	20	100	0,026	SZA032XXXX
40	20,5	39,5	5	25	0,048	SZA040XXXX
50	23,5	47,0	5	25	0,078	SZA050XXXX
63	27,5	53,5		5	0,170	SZA063XXXX
75	30,0	60,0		5	0,262	SZA075XXXX
90	33,0	69,0		1	0,425	SZA090XXXX
110	37,0	79,0		1	0,715	SZA110XXXX

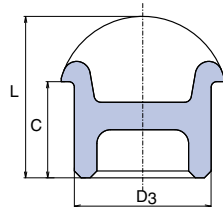
Капа за УКБ

D ₃	C	L	☐	☐	⚖	КОД
mm	mm	mm	I.	II.	кг/бр	
20,0	14,3	23,5	40	160	0,004	SZA120XXHE

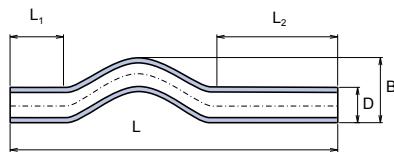
Тръба с гънка S 2,5 / PN 20 / SDR 6

D ₃	S	B	L	L ₁	L ₂	☐	☐	⚖	КОД
mm	(PN20)	mm	mm	mm	mm	I.	II.	кг/бр	
16	2,5 (20)	35,0	400,0	80,0	180,0	10	0,044		SKR016P20X
20	2,5 (20)	47,0	400,0	80,0	180,0	10	50	0,070	SKR020P20X
25	2,5 (20)	52,0	400,0	80,0	120,0	10	50	0,110	SKR025P20X
32	2,5 (20)	65,0	390,0	64,0	106,0	5	20	0,174	SKR032P20X
40	2,5 (20)	65,0	390,0	64,0	106,0	5	20	0,268	SKR040P20X

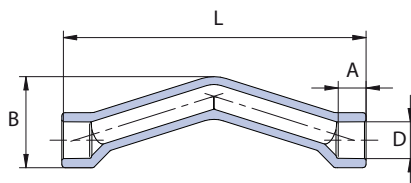
Тръба с гънка муфрана S 2,5 (PN20)

D	S	A	B	L	☐	☐	⚖	КОД
mm	(PN20)	mm	mm	mm	I.	II.	кг/бр	
20	2,5 (20)	14,5	33,4	160,0	10	50	0,041	SKRH020P20
25	2,5 (20)	16,0	44,2	200,0	10	50	0,089	SKRH025P20

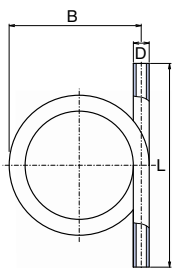
Компенсатор S 2,5 / PN 20 / SDR 6

D	S	B	L	☐	⚖	КОД
mm	(PN20)	mm	mm		кг/бр	
16	2,5 (20)	185,0	320,0	10	0,090	SKS016P20X
20	2,5 (20)	200,0	450,0	10	0,174	SKS020P20X
25	2,5 (20)	210,0	440,0	10	0,264	SKS025P20X
32	2,5 (20)	230,0	410,0	5	0,430	SKS032P20X
40	2,5 (20)	290,0	450,0	3	0,786	SKS040P20X

Изделия за питейна (студена) вода, топла вода и отопление (I.)

Преход с вътрешна месингова резба

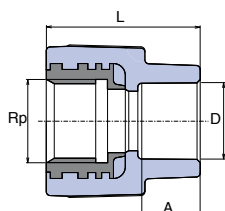

D	Rp	A	L	☒	☒	⚖	КОД
мм	мм	мм	мм	I.	II.	кг/бр	
16	1/2"	13,0	38,0	10	50	0,050	SZI01620XX
20	1/2"	14,5	39,0	10	250	0,056	SZI02020XX
20	3/4"	14,5	42,0	10	100	0,072	SZI02025XX
25	1/2"	16,0	40,5	10	50	0,062	SZI02520XX
25	3/4"	16,0	47,0	10	100	0,075	SZI02525XX
32	3/4"	18,0	45,0	10	30	0,081	SZI03225XX
32	1"	18,0	57,0	10	60	0,148	SZI03232OK
40	5/4"	20,5	65,0	5	10	0,260	SZI04040XX
50	6/4"	23,5	69,0	4		0,328	SZI05050XX
63	2"	27,5	76,0	2		0,616	SZI06363XX

Преход за стена с вътрешна месингова резба

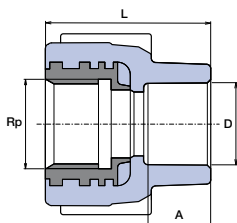

D	Rp	A	L	☒	☒	⚖	КОД
мм	мм	мм	мм	I.	II.	кг/бр	
20	1/2"	14,5	42,0	10	100	0,058	SZI02020XX

Преход с външна месингова резба

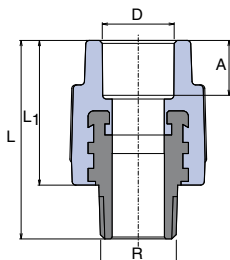

D	R	A	L	L ₁	☒	☒	⚖	КОД
мм	мм	мм	мм	мм	I.	II.	кг/бр	
16	1/2"	13,0	52,0	37,5	10	50	0,064	SZE01620XX
20	1/2"	14,5	53,5	39,0	10	150	0,062	SZE02020XX
20	3/4"	14,5	58,0	40,0	10	100	0,096	SZE02025XX
25	1/2"	16,0	55,5	41,0	10	60	0,066	SZE02520XX
25	3/4"	16,0	59,0	41,0	20	100	0,098	SZE02525XX
32	3/4"	18,0	60,0	44,0	10	30	0,105	SZE03225XX
32	1"	18,0	62,5	46,0	10	60	0,170	SZE03232XX
32	1"	18,0	69,5	42,0	10	60	0,204	SZE03232OK
40	5/4"	20,5	80,0	48,0	5	10	0,312	SZE04040XX
50	6/4"	23,5	81,6	54,0	4		0,460	SZE05050XX
63	2"	27,5	101,0	63,5	2		0,758	SZE06363XX
75	2 1/2"	30,0	110,0	69,7	1		1,150	SZE07575XX
90	3"	33,0	130,0	85,0	1		1,774	SZE09090XX

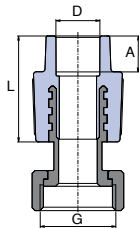
Преход с холендрова гайка

D	G	A	L	⊞	⊞	⚖	КОД
MM		MM	MM	I.	II.	кг/бр	
16	1/2"	13,0	32,0	10		0,044	SZM01620XX
16	3/4"	13,0	32,0	10		0,082	SZM01625XX
20	1/2"	14,5	40,0	20	100	0,048	SZM02020XX
20	3/4"	14,5	39,0	20	100	0,082	SZM02025XX
20	1"	14,5	39,0	5	10	0,152	SZM02032XX
25	3/4"	16,0	41,1	20	100	0,086	SZM02525XX
25	1"	16,0	41,0	4		0,154	SZM02532XX
32	5/4"	18,0	48,0	2		0,254	SZM03240XX
⊕ PMD							
20	3/4"	14,5	39,0	10		0,084	SZMD02025X
⊕ PMD – накидна гайка с отверстием для пломбы							

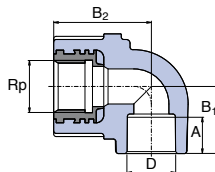
Коляно 90° с вътрешна месингова резба

D	Rp	A	B ₁	B ₁	⊞	⊞	⚖	КОД
MM		MM	MM	MM	I.	II.	кг/бр	
16	1/2"	13,0	25,2	31,0	10	50	0,062	SKOI01620X
20	1/2"	14,5	27,0	34,5	10	100	0,062	SKOI02020X
20	3/4"	14,5	27,0	40,0	10	50	0,082	SKOI02025X
25	1/2"	16,0	31,0	36,0	10	50	0,070	SKOI02520E
25	3/4"	16,0	30,0	41,0	10	100	0,090	SKOI02525X
32	1"	18,0	36,0	51,0	5	50	0,168	SKOI03232X

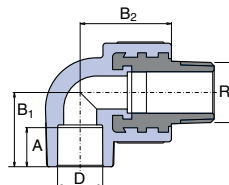
Коляно 90° с външна месингова резба

D	Rp	A	B ₁	B ₁	⊞	⊞	⚖	КОД
MM		MM	MM	MM	I.	II.	кг/бр	
16	1/2"	13,0	25,2	31,0	10	50	0,074	SKOE01620X
20	1/2"	14,5	27,0	34,5	10	100	0,074	SKOE02020X
20	3/4"	14,5	27,0	39,0	10	50	0,112	SKOE02025X
25	1/2"	16,0	31,0	36,0	10	50	0,082	SKOE02520E
25	3/4"	16,0	30,0	39,0	10	80	0,116	SKOE02525X
32	1"	18,0	36,0	41,6	5	40	0,118	SKOE03232X

Изделия за питейна (студена) вода, топла вода и отопление (I.)

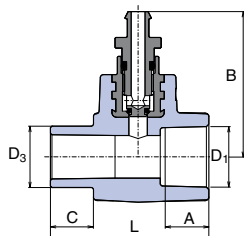

Изпускател (изпускателна муфа)

D	D ₃	A	L	B	C	⊞	⊞	⚖	КОД
mm	mm	mm	mm	mm	mm	I.	II.	kg/bp	
20	20	14,5	53,0	48,0	13,0	10	20	0,054	SNAV120XX
25	25	16,0	54,0	49,7	14,0	5	15	0,064	SNAV125XX
32	32	18,0	59,0	53,2	16,0	5	10	0,084	SNAV132XX

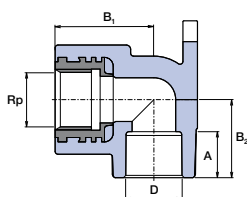

Коляно за стена с вътрешна месингова резба

D	Rp	A	B ₁	B ₂	⊞	⊞	⚖	КОД
mm		mm	mm	mm	I.	II.	kg/bp	
16	1/2"	13,0	32,0	23,2	10	60	0,064	SNK016XXXX
20	1/2"	14,5	34,0	26,8	10	150	0,068	SNK020XXXX
25	1/2"	16,0	36,0	27,5	10	50	0,072	SNK02520XX
25	3/4"	16,0	39,0	29,5	10	50	0,098	SNK025XXXX

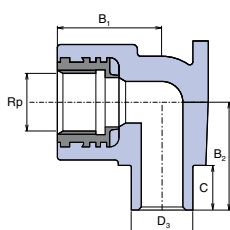

Коляно за стена с вътрешна месингова резба – мъжко

D ₃	Rp	B ₁	B ₂	C	⊞	⊞	⚖	КОД
mm		mm	mm	mm	I.	II.	kg/bp	
20	1/2"	34,0	32,2	11,0	10	120	0,068	SNK120XXXX

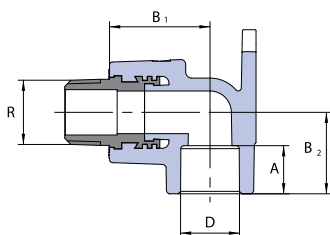

Коляно за стена с външна месингова резба

D	R	B ₁	B ₂	A	⊞	⊞	⚖	КОД
mm		mm	mm	mm	I.	II.	kg/bp	
20	1/2"	47,5	27	14,5	10	50	0,072	SNKE02020X

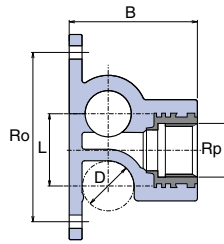
Ексцентрично коляно дясно

D	A	Rp	B	Ro	L	☒	☒	⚖	КОД
MM	MM		MM	MM	MM	I.	II.	кг/бр	
20	14,5	1/2"	50,0	66,0	28,5	5	25	0,066	SNK020KPXX

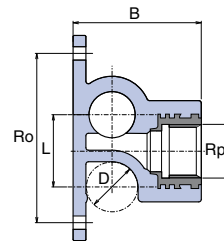
Ексцентрично коляно ляво

D	A	Rp	B	Ro	L	☒	☒	⚖	КОД
MM	MM		MM	MM	MM	I.	II.	кг/бр	
20	14,5	1/2"	50,0	66,0	28,5	5	25	0,066	SNK020KLXX

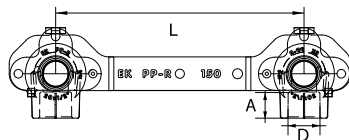
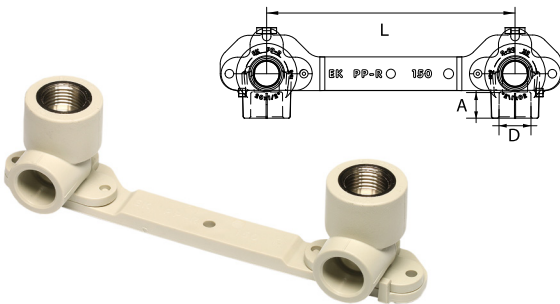
Колена за стена с фиксатор

D	A	L	☒	☒	⚖	КОД
MM	MM	MM	I.	II.	кг/бр	
20	14,5	150	10	50	0,162	SNKD02020X

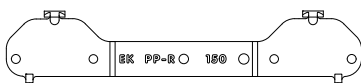
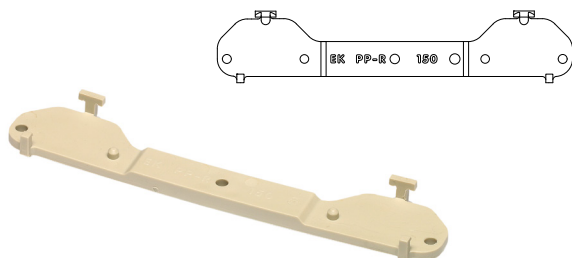
Фиксатор колена за стена

D	L	☒	☒	⚖	КОД
MM	MM	I.	II.	кг/бр	
20	150	10	50	0,026	SDNKXXXXXX

Изделия за питейна (студена) вода, топла вода и отопление (I.)

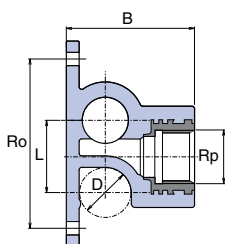

Тройник за стена с вътрешна месингова резба

D	A	Rp	B	Ro	L	☰ I.	☰ II.	⚖ кг/бр	КОД
20	14,5	1/2"	50,0	66,0	28,5	20	100	0,080	SNKP020XXX
25	16,0	1/2"	56,0	76,0	33,5	10	50	0,090	SNKP02520X

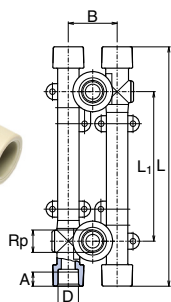

Универсален комплект за батерия

D	Rp	A	B	⊙ L1	L	☰ I.	☰ II.	⚖ кг/бр	КОД
20	1/2"	14,5	46,0	105/130/145	229,0	1	10	0,220	SNKK020XXX
25	1/2"	16,0	51,0	110/125/140	230,0	1	10	0,268	SNKK025XXX

⊙ L1 - для шага 100, 135, 150 мм, необходимо выровнять с помощью эксцентрического переходника

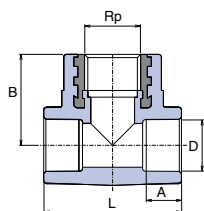

Тройник с вътрешна месингова резба

D	Rp	A	L	B	☰ I.	☰ II.	⚖ кг/бр	КОД
20	1/2"	14,5	51,5	34,0	10	100	0,068	STKI02020X
25	1/2"	16,0	80,0	40,0	10	100	0,076	STKI02520X
25	3/4"	16,0	80,0	40,0	5	30	0,094	STKI02525X
32	1/2"	18,0	71,0	40,5	5	25	0,106	STKI03220X
32	3/4"	18,0	71,0	42,0	5	25	0,118	STKI03225X
32	1"	18,0	80,0	55,0	5	20	0,186	STKI03232X

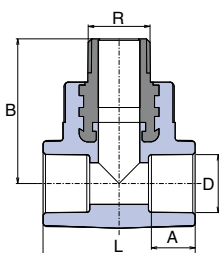

Тройник с външна месингова резба

D	R	A	L	B	☰ I.	☰ II.	⚖ кг/бр	КОД
20	1/2"	14,5	51,5	48,5	10	100	0,080	STKE02020X
20	3/4"	14,5	60,0	50,0	5	30	0,118	STKE02025X
25	1/2"	16,0	60,0	51,0	10	80	0,088	STKE02520X
25	3/4"	16,0	65,0	52,5	5	25	0,122	STKE02525X
32	3/4"	18,0	71,0	58,3	5	20	0,146	STKE03225X
32	1"	18,0	80,0	60,0	5	20	0,208	STKE03232X

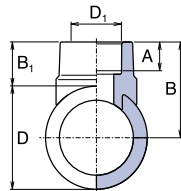
Седло - отклонение

D	D ₁	A	B ₁	B				КОД
MM	MM	MM	MM	MM	I.	II.	кг/бр	
63	32	18,0	27,0	58,5	10	50	0,034	SNS06332XX
75	32	18,0	27,0	64,5	10	50	0,032	SNS07532XX
90	32	18,0	27,0	72,0	10	50	0,034	SNS09032XX
110	32	18,0	25,7	80,7	5	40	0,044	SNS11032XX
110	40	20,5	25,7	80,7	5	40	0,048	SNS11040XX

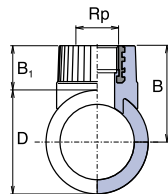
Седло - отклонение с вътрешна резба

D	Rp	B ₁	B			КОД
MM		MM	MM		кг/бр	
63	3/4"	27,0	58,5	10	0,084	SNSI06325X
75	3/4"	27,0	64,5	10	0,084	SNSI07525X
90	3/4"	27,0	72,0	10	0,084	SNSI09025X

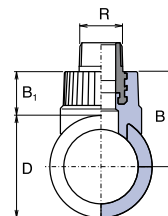
Седло - отклонение с външна резба

D	R	B ₁	B			КОД
MM		MM	MM		кг/бр	
63	3/4"	44,8	76,3	10	0,112	SNSE06325X
75	3/4"	44,8	82,3	10	0,110	SNSE07525X
90	3/4"	44,8	89,8	10	0,110	SNSE09025X

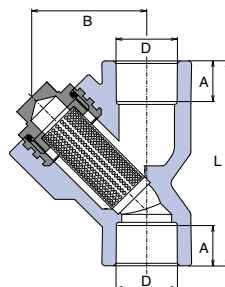
Филтър

D	B	L	A				КОД
MM	MM	MM	MM	I.	II.	кг/бр	
20	45,0	76,0	14,5	5	40	0,116	SFI020XXXX
25	45,0	82,0	16,0	5	40	0,134	SFI025XXXX
32	55,0	95,0	18,0	5	40	0,234	SFI032XXXX

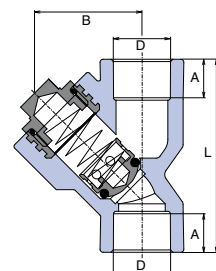
Възвратна клапа

D	B	L	A				КОД
MM	MM	MM	MM	I.	II.	кг/бр	
20	45,0	76,0	14,5	5	40	0,136	SZKL020XXX
25	45,0	82,0	16,0	5	40	0,154	SZKL025XXX
32	55,0	95,0	18,0	5	40	0,266	SZKL032XXX

Изделия за питейна (студена) вода, топла вода и отопление (I.)

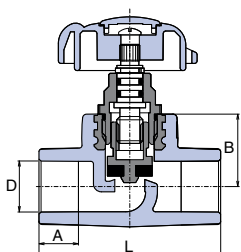

Кран кеклов

D	A	B	L	📦 I.	📦 II.	⚖️ кг/бр	КОД
20	14,5	27,5	69,0	10	50	0,140	SVE020XXXX
25	16,0	30,0	80,0	10	30	0,192	SVE025XXXX
32	18,0	39,0	89,0	5	15	0,380	SVE032XXXX
40	20,5	41,0	112,0		5	0,542	SVE040XXXX
50	23,5	48,0	136,0		1	0,732	SVE050XXXX
63	27,5	60,0	162,0		1	1,330	SVE063XXXX



ръкохватка



патрон

Резервни части

ръкохватка

D	📦 I.	📦 II.	⚖️ кг/бр	КОД
20 - 25	1	5	0,015	STOCVM02025S
32 - 40	1	5	0,028	STOCVS03240S
50 - 63	1	1	0,041	STOCV05063S

патрон

20	1	5	0,080	VRV020XXXX
25	1	5	0,129	VRV025XXXX
32	1	5	0,211	VRV032XXXX
40	1	1	0,280	VRV040XXXX
50	1	1	0,293	VRV050XXXX
63	1	1	0,460	VRV063XXXX

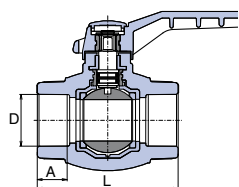

Кран сферичен

D	A	L	📦 I.	📦 II.	⚖️ кг/бр	КОД
16	13,0	59,5	10	50	0,092	SVEK016XXX
20	14,5	65,0	10	50	0,116	SVEK020XXX
25	16,0	71,0	10	40	0,168	SVEK025XXX
32	18,0	85,0	10	20	0,294	SVEK032XXX
40	20,5	100,0	5	10	0,544	SVEK040XXX
50	23,5	115,0	1	5	0,874	SVEK050XXX
63	27,5	134,0	1	5	1,278	SVEK063XXX

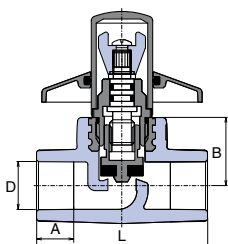

Секретен кран кеклов с метална камбанка

D	A	B	L	📦 I.	📦 II.	⚖️ кг/бр	КОД
20	14,5	27,5	69,0	5	20	0,208	SVEPLK020X
25	16,0	30,0	80,0	5	20	0,270	SVEPLK025X

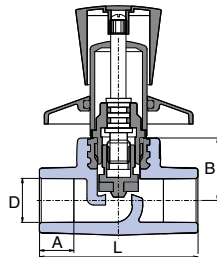

Кеклов кран лукс

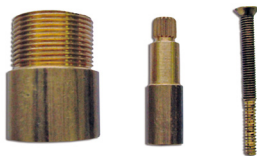
D	A	B	L	☞	☞	⚖	КОД
MM	MM	MM	MM	I.	II.	кг/бр	
20	14,5	27,5	69,0	5	20	0,338	SVEPLR020X
25	16,0	30,0	80,0	5	20	0,392	SVEPLR025X

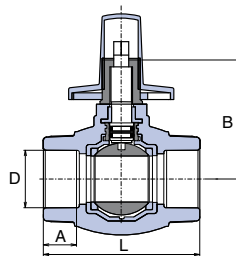

Удължител за кран D 20, 25 мм

☞	⚖	КОД
	кг/бр	
1	0,071	VEPL020XXX

Удължения за кранове под мазилка Ø 20, 25 мм.

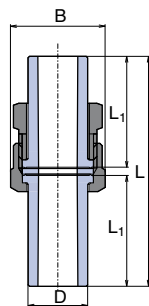

Секретен кран сферичен с метална камбанка

D	A	B	L	☞	☞	⚖	КОД
MM	MM	MM	MM	I.	II.	кг/бр	
20	14,5	67,0	65,0	5	20	0,254	SVEKPLK020
25	16,0	65,0	71,0	5	20	0,334	SVEKPLK025

Холендрова връзка

D	B	L	L ₁	☞	☞	⚖	КОД
MM	MM	MM	MM	I.	II.	кг/бр	
20	30,0	82,0	40,0	20	100	0,088	SRS020XXXX
25	38,0	82,0	40,0	20	100	0,142	SRS025XXXX
32	46,0	92,0	45,0	10	50	0,212	SRS032XXXX
40	58,0	112,0	55,0	5	5	0,288	SRS040XXXX

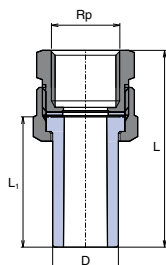
Изделия за питейна (студена) вода, топла вода и отопление (I.)



Холендрова връзка с вътрешна резба

D	Rp	L	L ₁	⊞	⊞	⚖	КОД
mm		mm	mm	I.	II.	kg/bp	
20	1/2"	60,0	40,0	10	100	0,086	SSI02020XX
25	3/4"	62,0	40,0	10	70	0,136	SSI02525XX
32	1"	70,0	45,0	10	50	0,220	SSI03232XX

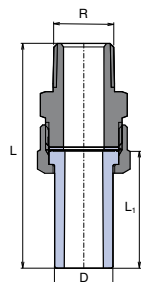

Холендрова връзка с външна резба

D	R	L	L ₁	⊞	⊞	⚖	КОД
mm		mm	mm	I.	II.	kg/bp	
20	1/2"	77,0	40,0	10	100	0,118	SSE02020XX
25	3/4"	80,0	40,0	10	50	0,196	SSE02525XX
32	1"	92,0	45,0	10	40	0,324	SSE03232XX

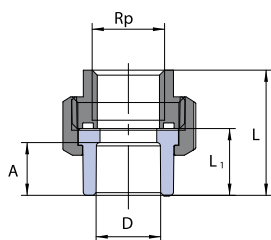

Холендрова връзка с муфа и вътрешна резба

D	Rp	L	L ₁	⊞	⊞	⚖	КОД
mm		mm	mm	I.	II.	kg/bp	
20	1/2"	37,5	19,5	10	100	0,122	SSHI02020X
25	3/4"	46,5	23,0	10	70	0,213	SSHI02525X

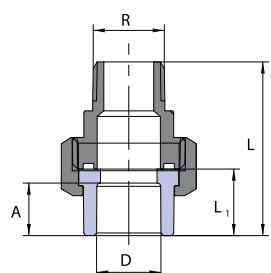

Холендрова връзка с муфа и външна резба

D	Rp	L	L ₁	⊞	⊞	⚖	КОД
mm		mm	mm	I.	II.	kg/bp	
20	1/2"	52,5	19,5	10	100	0,142	SSHE02020X
25	3/4"	59,0	23,0	10	70	0,223	SSHE02525X

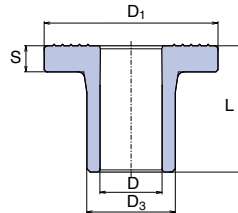
Втулка за фланец

D ₃	L	D ₁	S	D	☐ I.	☐ II.	⚖️ кг/бр	КОД
мм	мм	мм	мм	мм				
40	58,0	80,0			2	10	0,072	SLN040XXXX
50	60,0	90,0	12,5		2	10	0,102	SLN050XXXX
63	62,0	105,0	13,5		1	10	0,156	SLN063XXXX
75	73,0	123,0	14,7		1	5	0,244	SLN075XXXX
90	92,0	140,0	17,0		1		0,400	SLN090XXXX
110	103,0	160,0	19,0		1		0,618	SLN110XXXX
Редуктивна втулка за фланец								
165	63,0	188,0	20,0	⊕ 125	1		0,697	SLN125XXXX

⊕ Информация за срока на доставка при поискване.

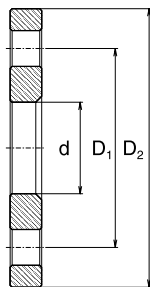
Фланец

	D ₁	D ₂	d	⊕ Y	☐	⚖️ кг/бр	КОД
	мм	мм	мм				
40 / DN32	100,0	140,0	46,0	4	1	1,660	PRI040NXXX
50 / DN40	110,0	150,0	54,0	4	1	1,802	PRI050NXXX
63 / DN50	125,0	165,0	66,0	4	1	2,414	PRI063NXXX
75 / DN65	145,0	185,0	83,0	8	1	2,978	PRI075NXXX
90 / DN80	160,0	200,0	94,0	8	1	3,490	PRI090NXXX
110 / DN100	180,0	220,0	114,0	8	1	4,098	PRI110NXXX
125 / DN150	210,0	250,0	166,0	8	1	4,450	PRI125NXXX

⊕ Y – брой на отворите

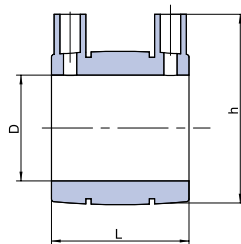
Електромуфа

D	A	L	☐	⚖️ кг/бр	КОД
мм	мм	мм			
20	70	52	1	0,04	ENA020PPRCT
25	70	58	1	0,05	ENA025PPRCT
32	70	65	1	0,07	ENA032PPRCT
40	85	75	1	0,10	ENA040PPRCT
50	88	87	1	0,16	ENA050PPRCT
63	98	100	1	0,26	ENA063PPRCT
75	125	114	1	0,41	ENA075PPRCT
90	146	130	1	0,51	ENA090PPRCT
110	155	144	1	0,80	ENA110PPRCT
⊕ 125	166	167	1	0,95	ENA125PPRCT

⊕ Информация за срока на доставка при поискване.

Комплексно предложение на фитинги за гипсокартон (I.)

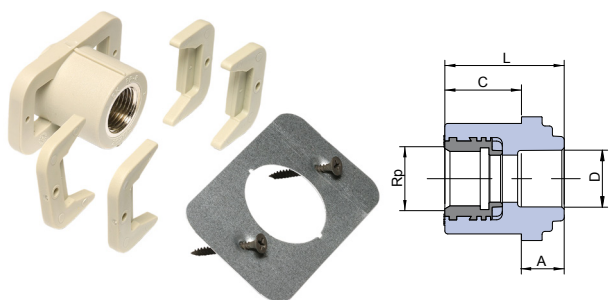

Преход за гипсокартон

D	Rp	A	C	L	📦	📦	⚖️	КОД
MM		MM	MM	MM	I.	II.	кг/бр	
20	1/2"	14,5	26,0	40,5	1	10	0,102	SZS02020X

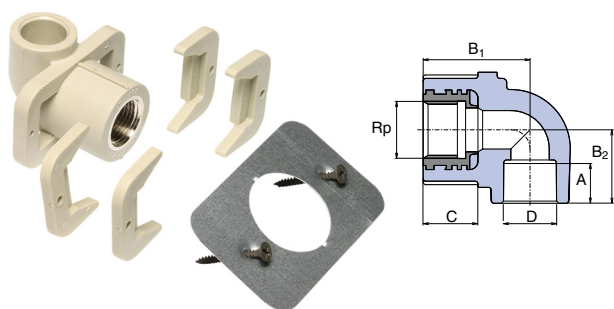

Коляно за гипсокартон

B	Rp	A	B ₁	B ₂	C	📦	📦	⚖️	КОД
MM		MM	MM	MM	MM	I.	II.	кг/бр	
20	1/2"	15	44,0	27,0	26,0	1	10	0,114	SNKS020SX

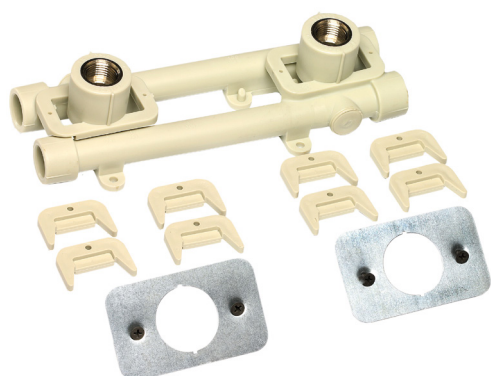

Универсален комплект за батерия за гипсокартон

D	Rp	A	B	L ₁	L	C	📦	⚖️	КОД
MM		MM	MM	MM	MM	MM		кг/бр	
20	1/2"	14,5	49,0	100/135/150	234,0	26,0	10	0,320	SNKK020SXX

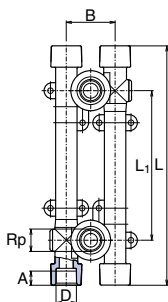

Специални фитинги за отопление (I.)

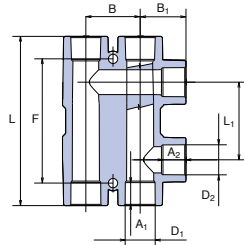

Отклонение към радиатор

D1	D2	A1	A2	L1	L	B1	B	☒	☒	⚖	КОД
мм	мм	мм	мм	мм	мм	мм	мм	I.	II.	кг/бр	
20	20	14,5	14,5	50	109	29,5	35	1	20	0,098	SRAO02020X
25	20	16,0	14,5	50	115	32,0	45	1	20	0,138	SRAO02520X

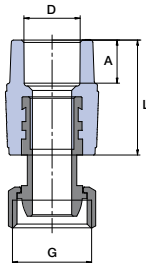

Преход с холандрова гайка и евроконус

D	G	A	L	☒	☒	⚖	КОД
мм		мм	мм	I.	II.	кг/бр	
20	3/4"	14,5	40,0	5	25	0,089	SZM02025EX

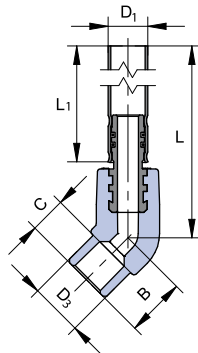

Връзка към радиатор – коляно 45 °

D1	D3	B	C	L	L1	☒	☒	⚖	КОД
мм	мм	мм	мм	мм	мм	I.	II.	кг/бр	
15	20	22,5	13	298	270	1	20	0,123	SKORP12045270
15	20	22,5	13	748	720	1	10	0,270	SKORP12045720

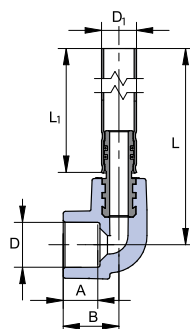

Връзка към радиатор – коляно 90 °

D	D1	A	B	L	L1	☒	☒	⚖	КОД
мм	мм	мм	мм	мм	мм	I.	II.	кг/бр	
20	15	14,5	24	300	270	1	20	0,126	SKORP02090270
20	15	14,5	24	750	720	1	10	0,273	SKORP02090720

Специални фитинги за отопление (I.)

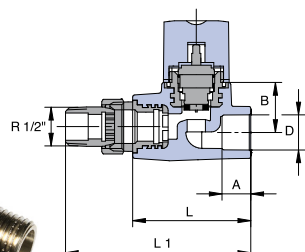

Термостатичен вентил за радиатор - прав

D	A	B	L	L ₁	R	☞ I.	☞ II.	⚖ кг/бр	КОД
20	14,5	24,5	65	102	1/2"	5	20	0,265	SVER020PXX

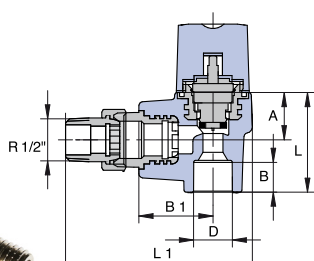

Термостатичен вентил за радиатор - ъглов

D	A	B	B ₁	L	L ₁	R	☞ I.	☞ II.	⚖ кг/бр	КОД
20	14,5	23,5	36,5	49,5	93	1/2"	5	20	0,269	SVER020RXX



Глава за термостатичен вентил

☞ I.	☞ II.	⚖ кг/бр	КОД
5	20	0,126	ТЕНLAXXXX

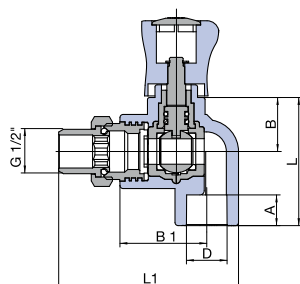

Вентил за радиатор - ъглов

D	A	B	L	L ₁	☞ I.	☞ II.	⚖ кг/бр	КОД
20	14,5	25,5	60	89	5	20	0,188	SVER020KXX

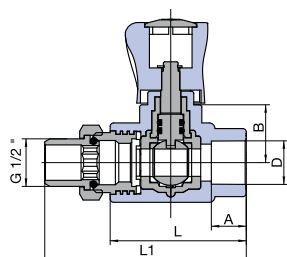

Вентил за радиатор - прав

D	A	B	B ₁	L	L ₁	☞ I.	☞ II.	⚖ кг/бр	КОД
20	14,5	25,5	41	60	85	5	20	0,192	SVER020XXX

Изделия само за питейна (студена) вода (II.)

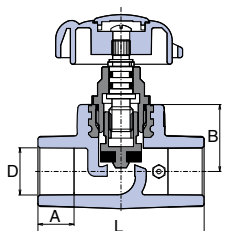

Кран кеклов с изпразнител

D	A	B	L	📦	⚖️	КОД
мм	мм	мм	мм		кг/бр	
десен						
40	20,5	41,0	112,0	1	0,578	SVEV040PXX
50	23,5	48,0	136,0	1	0,788	SVEV050PXX
63	27,5	60,0	162,0	1	1,388	SVEV063PXX
ляв						
40	20,5	41,0	112,0	1	0,572	SVEV040LXX
50	23,5	48,0	136,0	1	0,754	SVEV050LXX
63	27,5	60,0	162,0	1	1,416	SVEV063LXX

Произвежда се по поръчка със срок на доставка 30 дни.

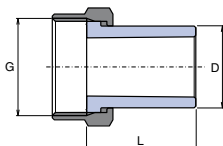

Холендър

D	G	L	📦 I.	📦 II.	⚖️	КОД
мм		мм			кг/бр	
20	3/4"	40,0	10	100	0,048	SHM02025XX
25	1"	40,0	10	50	0,074	SHM02532XX
32	5/4"	45,0	5	25	0,096	SHM03240XX

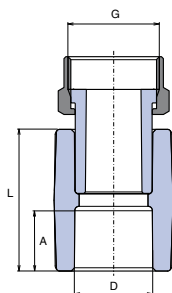

Муфа с холендрова гайка

A	Rp	B1	B2	📦 I.	📦 II.	⚖️	КОД
мм		мм	мм			кг/бр	
16	1/2"	13,0	33,0	10	50	0,032	SNAM01620X
20	1/2"	14,5	34,6	50	200	0,034	SNAM02020X
20	3/4"	14,5	34,6	25	200	0,056	SNAM02025X
25	3/4"	16,0	37,8	20	100	0,058	SNAM02525X
25	1"	16,0	37,8	10	50	0,092	SNAM02532X
32	1"	18,0	40,0	10	50	0,102	SNAM03232X
PMD							
20	3/4"	14,5	34,6	10	50	0,056	SNAMD02025
25	3/4"	16,0	37,8	10	50	0,062	SNAMD02525

PMD – холендрова гайка с отвор за пломбиране

Изделия само за питейна (студена) вода (II.)

Тройник с холендрова гайка

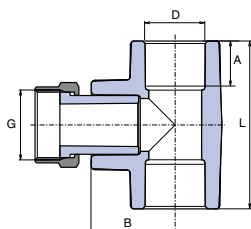

D	G	A	B	L	☎	☎	⚖	КОД
ММ		ММ	ММ	ММ	I.	II.	кг/бр	
20	3/4"	14,5	54,0	27,0	10	60	0,069	STKM02025X
25	3/4"	16,0	60,0	32,0	5	50	0,079	STKM02525X
25	1"	16,0	60,0	32,0	5	30	0,157	STKM02532X
32	3/4"	18,0	70,0	35,7	5	10	0,100	STKM03225X
32	1"	18,0	70,0	35,7	5	10	0,135	STKM03232X

Коляно 90° с холендрова гайка

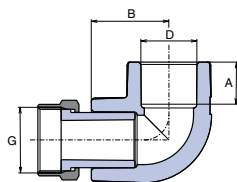

D	G	A	B	☎	☎	⚖	КОД
ММ		ММ	ММ	I.	II.	кг/бр	
20	1/2"	14,5	26,8	25	100	0,047	SKOM02020X
20	3/4"	14,5	26,8	25	100	0,062	SKOM02025X

Изделия за временно, нестандартно използване (III.)

Преход с външна пластмасова резба

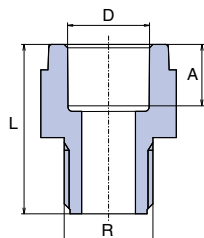

D	R	A	L	☎	☎	⚖	КОД
ММ		ММ	ММ	I.	II.	кг/бр	
20	1/2"	14,5	40,0	50	200	0,014	SDG02020XX
20	3/4"	14,5	38,0	50		0,012	SDG02025XX
25	3/4"	16,0	42,0	50		0,020	SDG02525XX
32	1"	18,0	54,0	25		0,038	SDG03232XX
40	5/4"	20,5	62,0	10		0,074	SDG04040XX
50	6/4"	23,5	63,0	10		0,094	SDG05050XX
63	2"	27,5	81,9	5		0,194	SDG06363XX

Принадлежности (IV.)

Планка за батерии

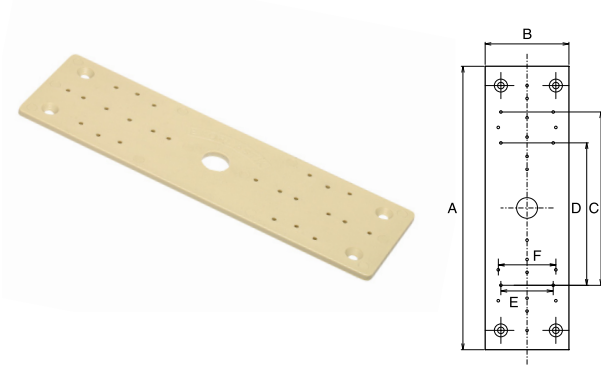

A	B	C	D	E	F				КОД
мм	мм	мм	мм	мм	мм	I.	II.	кг/бр	
220,0	64,0	135,0	110,0	45,0	40,0	10	50	0,058	DNPXXXXXXX

Скоба метална за дюбел

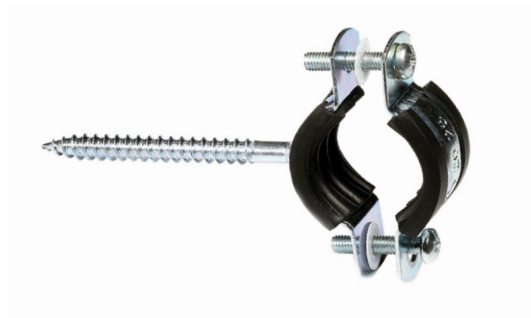

D				КОД
мм	I.	II.	кг/бр	
20-25	25	100	0,056	PRK02025XX
32-40	25	100	0,074	PRK03240XX
50-63	5	50	0,124	PRK06350XX

Скоба метална с гайка



D	гайка	шуруп				КОД
мм	мм	мм	I.	II.	кг/бр	
48 - 53	M8/10		5	50	0,078	PRKB04853X
72 - 78	M8/10		5	10	0,146	PRKB07278X
87 - 92	M8/10		5	10	0,180	PRKB08792X
102 - 116	M8/10		5	10	0,238	PRKB102116
		M8/100		10	0,023	VRUTM8100X

Принадлежности (IV.)



Скоба пластмасова

D	📦	📦	⚖️	КОД
MM	I.	II.	кг/бр	
16	50	300	0,004	PRE016XXXX
20	50	500	0,004	PRE020XXXX
25	50	500	0,006	PRE025XXXX
32	50	300	0,008	PRE032XXXX
⊕ 40	1	50	0,016	PRP040XXXX
⊕ 50	1	25	0,034	PRP050XXXX
⊕ 63	1	25	0,046	PRP063XXXX
⊕ 75		1	0,084	PRP075XXXX
⊕ 90		1	0,114	PRP090XXXX
⊕ 110		1	0,136	PRP110XXXX

⊕ с зажимом

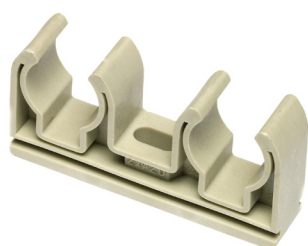

Двойна скоба пластмасова

D	📦	⚖️	КОД
MM		кг/бр	
2x20	1	0,016	PRDV0202XX
2x25	1	0,022	PRDV0252XX



Пояльник RSP 2a с електронно регулиране

	W	📦	⚖️	КОД
			кг/бр	
RSP 2a	700	1	1,328	SVARSP2AXEL



Пояльник плосък RSP 2aPm с електронно регулиране

	W	📦	⚖️	КОД
			кг/бр	
RSP 2aPm	800	1	1,428	SVARSP2APEL

Заваръчен комплект с накрайници 16-63 mm

	W		⚖	КОД
			кг/бр	
RSP 2a	700	насадки Ø 16 – 63	9,223	SVAKRSP2A6E
RSP 2aPm	800	насадки Ø 16 – 63	8,645	SVAKRSP2P6E

Съдържа ножици PROFI, ключ, рулетка, стойка, накрайници и поялник съобразно поръчката

Заваръчен комплект с накрайници 20-32 mm

	W		⚖	КОД
			кг/бр	
RSP 2a	700	насадки Ø 20 – 32	4,545	SVAKRSP2A3E
RSP 2aPm	800	насадки Ø 20 – 32	4,490	SVAKRSP2P3E

Съдържа ножици PROFI, ключ, рулетка, стойка, накрайници и поялник съобразно поръчката

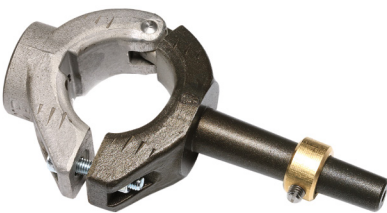
Ремонтен накрайник

	📦	⚖	КОД
		кг/бр	
комплектът	1	0,186	OSAXXXXXXX

Комплектът съдържа накрайник Ø 12 mm. и 5 бр. ремонтни щифтове Ø 12 mm

Ремонтен щифт

Ø	📦	⚖	КОД
mm		кг/бр	
12	1 (5)	0,029	OTXXXXXXX

Принадлежности (IV.)

Апарат за ел. муфи – ELEKTRA LIGHT



	W	📦	⚖️ кг/бр	КОД
20 – 125/160 мм	2000	1	8,000	SVAELEKTRAL

Произвежда се по поръчка със срок на доставка 30 дни.

Накрайници плоски

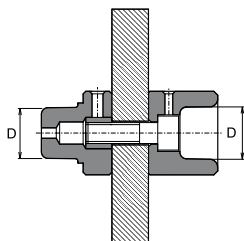



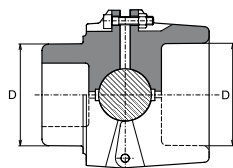

D мм	📦	⚖️ кг/бр	КОД
16	1	0,074	NAP016XXXX
20	1	0,078	NAP020XXXX
25	1	0,138	NAP025XXXX
32	1	0,164	NAP032XXXX
40	1	0,308	NAP040XXXX
50	1	0,333	NAP050XXXX
63	1	0,493	NAP063XXXX
75	1	0,653	NAP075XXXX
90	1	1,089	NAP090XXXX
110	1	1,681	NAP110XXXX
125	1	1,996	NAP125XXXX

Накрайник кръгъл

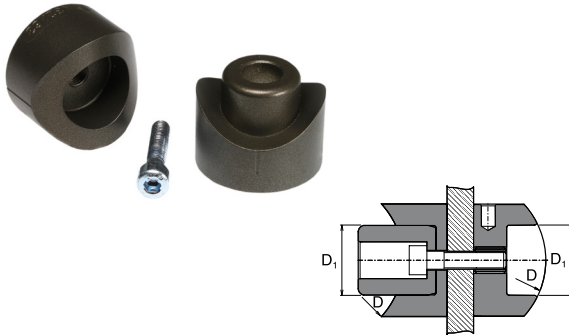

D мм	📦	⚖️ кг/бр	КОД
16	1	0,130	NA016CXXXX
20	1	0,133	NA020CXXXX
25	1	0,178	NA025CXXXX
32	1	0,215	NA032CXXXX
40	1	0,379	NA040CXXXX
50	1	0,517	NA050CXXXX
63	1	0,822	NA063CXXXX

Накрайник за седло - отклонение

D	D ₁			КОД
ММ	ММ		кг/бр	
63	32	1	0,298	SNNS06332X
75	32	1	0,296	SNNS07532X
90	32	1	0,296	SNNS09032X
 110	40	1	0,432	SNNS11040X

 за отклонения от 110 към Ø 32 и Ø 40.

Монтажно приспособление MP-125

	D			КОД
	ММ		кг/бр	
MP-125	63-125	1	37,200	SVAMP125XX

MP 125 съдържа рама, стойка с паялник 1400 W и куфарче с принадлежности

Произвежда се по поръчка със срок на доставка 30 дни.

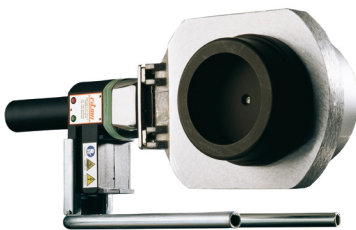
Поялник PRISMA 125

W			КОД
		кг/бр	
1400	1	2,760	SVA125XXXX

Произвежда се по поръчка със срок на доставка 30 дни.

Термометър DT-METR

			КОД
		кг/бр	
DT-METER	1	0,940	TEPODXXXXX

Принадлежности (IV.)



Лентов ключ

		КОД
1	0,297 кг/бр	UKXXXXXXXXX



Ножици PROFI

	D мм			КОД
PROFI	16-40	1	0,383 кг/бр	NU042PXXXX



Ножици M2

	D мм			КОД
M2	16-63	1	1,241 кг/бр	NU063XXXXX



Режеща ролка (тръборез)

D мм			КОД
50-140	1	1,420 кг/бр	REZ050140X

Острилка за тръби с AL слой – STABI

D ₁ мм	📦	⚖️ кг/бр	КОД
16-20	1	0,134	REZS01620X
20-25	1	0,156	REZS02025X
25-32	1	0,206	REZS02532X
32-40	1	0,266	REZS03240X
50	1	0,302	REZS050XXX
63	1	0,352	REZS063XXX
75	1	0,386	REZS075XXX
90	1	0,634	REZS090XXX
110	1	0,870	REZS110XXX

Острилка за STABI за работа с бормашина

D мм	📦	⚖️ кг/бр	КОД
40	1	0,290	REZS040VXX
50	1	0,882	REZS050VXX
63	1	0,406	REZS063VXX
щифт за острилка	1	0,020	СЕРXXXXXXX

Свредел за седло - отклонение

D мм	📦	⚖️ кг/бр	КОД
32	1	0,200	VNS032XXXX
40	1	0,300	VNS040XXXX

Улей поцинкован

D мм	I мм	📦 I.	📦 II.	⚖️ кг/бр	КОД
20	2000	1	25	0,331	ZLSP20XXXX
25	2000	1	25	0,428	ZLSP25XXXX
32	2000	1	25	0,516	ZLSP32XXXX
40	2000	1	25	0,607	ZLSP40XXXX
50	2000	1	25	0,732	ZLSP50XXXX
63	2000	1	25	0,879	ZLSP63XXXX

Принадлежности (IV.)



Тапа къса

G	📦 I.	📦 II.	⚖️ кг/бр	КОД
1/2"	50	250	0,008	ZAGXXXXXXX

Тапите са комплект с гумен "О" пръстен.



Тапа дълга

G	📦 I.	📦 II.	⚖️ кг/бр	КОД
1/2"	50	250	0,022	ZAGDXXXXXX

Тапите са комплект с гумен "О" пръстен.



Паста за резби

гр	📦	⚖️ кг/бр	КОД
10	1	0,018	TMSIS10XXX
100	1	0,124	TMSIS100XX



Тефлонов конец за уплътнение на резби

м	⚖️ кг/бр	КОД
50	0,053	TTN50XXXXX
150	0,126	TTN150XXXXX

Сертификати



- ⦿ използването и монтажът на изделията са регламентирани в инструкцията за монтаж на системата ekoplastik PPR
- ⦿ за стандартните изделия (I., II.) се предоставя гаранция от 10 години
- ⦿ за останалите изделия (III., IV.) се предоставя гаранция от 2 години
- ⦿ при производството и изпитанията се прилага стандарт ČSN EN ISO15874
- ⦿ системата за качество е сертифицирана по ISO 9001-2009

Използвани съкращения

КОД – код на изделието при поръчка

S (PN) – серия (гама за налягане)

I. – малки опаковки

II. – големи опаковки

G – вътрешна резба цилиндрична и неуплътняваща в резбата

Rp – вътрешна резба цилиндрична, уплътняваща в резбата

R – външна резба конусна, уплътняваща в резбата

WAVIN Ekoplastik непрекъснато развива и подобрява своите изделия и затова си запазва правото за модификации и промени в спецификациите на своите изделия, без предварително уведомление. Цялата информация в тази публикация беше изготвена с добро намерение и убеждението, че в деня на предаването ѝ за печат е актуална и не поражда съмнения. Настоящият каталог не е предложение по смисъла на закона, а съдържа информация за изделията.

Запознайте се нашия богат
асортимент в
www.ekoplastik.com



Инсталации за вода и отопление | Подово отопление
Климатизация | Вътрешна канализация

Mexichem.
Building & Infrastructure

wavin

EKOPLASTIK®

CONNECT TO BETTER

Дружеството Wavin предлага ефективни решения за неизбежните нужди във всекидневието ни: надежен пренос на питейна вода, обработка на дъждовни и отпадъчни води на база екология и постоянна развойна дейност. Водеща позиция на европейския пазар, активно участие на отделните пазари и особено внимание на техническата подкрепа и новостите; всичко това е сигурна гаранция за всички наши клиенти. Успяваме дългосрочно да постигаме най-високите стандарти в областта на поддържането и осигуряването на надеждна подкрепа на клиентите си, за да можем да изпълниме всичките им желания.

ЕВРО ПЛАСТИКА

ЕВРОПЛАСТИКА ЕООД | ул. Банско шосе № 57, 1390 София
Tel. +359/29950 769 +359/29950 768 | +359/887 912 364 | +359/879 877 070
europlastica@abv.bg

WAVIN Ekoplastik s.r.o. | Rudeč 848 | 277 13 Kostelec nad Labem | Czech Republic | Phone +420/ 326 983 111 | Fax +420/ 326 983 110
Internet www.ekoplastik.com | E-mail ekoplastik@wavin.com